

INSTALLATION INSTRUCTIONS

UNLOADING & HANDLING

Lift joints from trucks. **DO NOT DROP SHARP OR HEAVY OBJECTS ON INSULATED UNITS.** **DO NOT** use chains or other devices which might puncture insulation jacket.

STORAGE

Pipe is stockpiled off the ground. Do not exceed a stacking height of 6'. Prevent dirt and debris from entering pipe. Fittings, joining materials, etc. must be stored indoors to protect them from freezing, overheating, moisture, or loss.

LAYING OF PIPE UNITS – TRENCHING

All sharp rocks, roots, and other abrasive material must be removed from the trench. The trench bed should be 6" of sand or backfill as specified by the engineer, providing a smooth and uniform stabilizing surface (sandbags may be used as a means to keep the pipe off the ground until backfilling is started). The trench width should provide a minimum of 6" from trench wall to jacket O.D. and a minimum of 6" between pipe units. Trench depths will be indicated on the contract drawing and in line with good construction practices. Trench depth should allow for a minimum cover of 24" on top of the insulated unit.

FIELD JOINING METHODS

Pipe should be laid straight and level. Installation that results in cocking of coupling or pinching of gasket is unacceptable.

1. Inspect carrier pipe ends for proper bevel. Any burrs or scratches should be touched up with grinder or fine tooth file. Slide sleeve cover over one end of jacket.
2. Rub a thin layer of lubricant over carrier pipe end and gasket. Use lubricant supplied by Thermacor. **Do NOT** use petroleum-based lubricant.
3. Insert pipe ends into DI coupling.** Take care not to damage pipe ends during installation. Partially backfill (see TESTING) and pressure test as per specifications.
4. Insulate DI coupling and slide sleeve over coupling so that there is equal overlap.
5. Wrap tape around each end of sleeve with overlap at the top. Rub out any tape wrinkles with knife hilt.

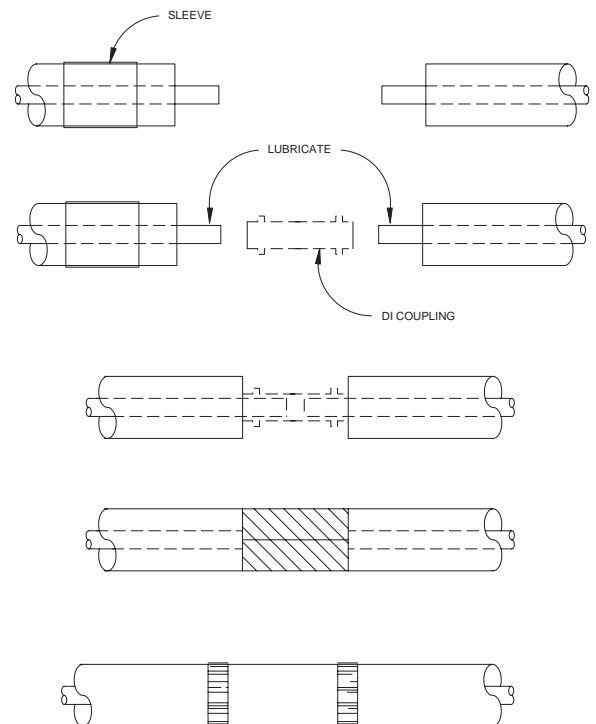

** Coupling must be cleaned before assembly. Be sure gasket groove is clean and that the gasket is seated properly. Lubricate smooth pipe spigot with Thermacor provided lubricant. Insert pipe spigot carefully to prevent cutting or rolling of gasket. Coupling should fit tightly against factory insulation.

FIELD ALTERATIONS

Pipe will be cut in the field, based on the appropriate field measurements for fittings and/ or making manhole or wall entries unless the system is pre-engineered with piece mark sections. If special short pieces are required, measure distance needed for field alteration and cut through unit with saw. Using factory insulated pipe as guide, cut back insulation and bevel pipe with a bevel that is approximately 15 degrees from pipe centerline and 3/4 of an inch long (simultaneously removing burrs, cuts, nicks, and scratches). Apply end seals to the clean, dry, exposed insulation surface. Where fittings are required, they must be welded, using approved welding methods with appropriate schedule fittings. If gasket DI fittings are used, the pipe must be beveled correctly. Do NOT put mastic on gasket.

BACKFILL INITIAL

After pipe is installed, specified backfill shall be tamped around the conduit in 6" layers to insure proper compaction. One foot on either side of each joint and fitting shall be left bare for visual inspection during testing.

TESTING

Sufficient backfill must be placed on pipe, and anchor blocks poured and cured, prior to testing. Bleed all air from lines to eliminate possible incorrect readings. The hydrostatic pressure test shall be performed per the engineer's specification with a factory recommendation of one and one-half times the normal operating pressure for not less than two hours. Inspect all fittings, valves, and couplings at this time. *Appropriate safety precautions shall be taken to guard against possible injury to personnel in the event of a failure.*

BACKFILL FINAL

Before backfilling is started, the trench should be cleaned of any trench wall cave-ins and general trash, especially metal. Backfilling should be done with sand or other engineer-approved material 6" below the casing to 1' above. Engineer-approved backfill may be used to fill the rest of the trench. This material should be free of rocks, roots, large clods, or anything that could cause damage to the jacket. Jacket should have a minimum of 2' cover.

WHEELED OR TRACKED VEHICLES SHALL NOT BE USED FOR TAMPING!

THRUST BLOCK INSTALLATION

The engineer who designs the system has the responsibility for designing and sizing the thrust blocks. A knowledge of site soil conditions is essential for proper design. Thermacor will not accept or assume responsibility for thrust blocks, and intends to provide basic data only.

WHY THRUST BLOCKS?

A Steel-Therm system must include thrust blocks to prevent the gasketed joints from separating under pressure. To prevent separation, thrust blocks must be located at:

1. All major changes in direction; i.e., tees and elbows (both horizontal and vertical).
2. All changes in size.
3. All terminal ends.
4. All Valves, so as to support the body weight and prevent excessive torque on pipe connections.
5. **IMPORTANT:** Any connecting welded steel pipe must be anchored at the point of connection to the Steel-Therm pipe to prevent excessive stresses from being transferred to the DI couplings.

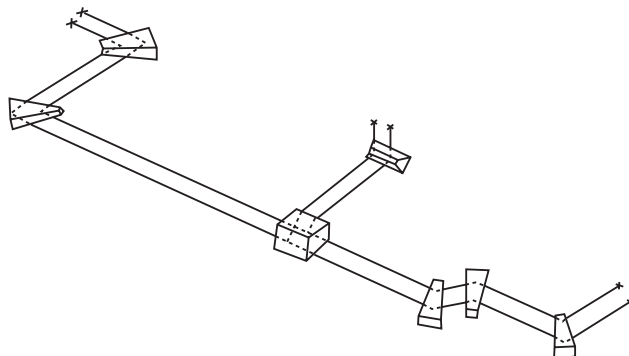

INSTALLATION

As thrust blocks are an essential part of the system, they should be poured before hydrostatic testing. Temporary thrust blocking may be used with extreme caution if absolutely necessary. The system must be retested after the permanent thrust blocks are poured and cured to verify that the thrust blocks will resist the thrust.

DESIGN

The design of the thrust blocks depends on test pressure, size, number of pipes, soil conditions, and types of fittings involved. Three conditions must be met for the thrust blocks to function properly.

1. The bearing area must be adequate to resist the pressure force.
2. The bearing surface must rest directly against undisturbed soil.
3. The face of the block bearing surface in the soil must be perpendicular to the resultant direction of thrust.

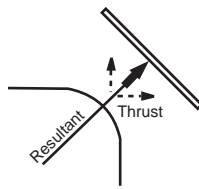

90° ELBOW

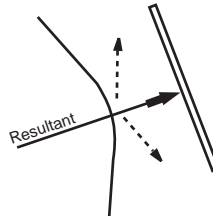

45° ELBOW

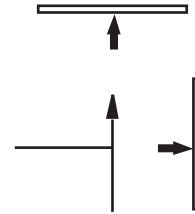

REDUCING TEE

If the thrust blocks have not been designed by the engineer, they must be sized by the following procedure:

Example: Design a thrust block to resist the horizontal thrust of two 4" chilled water lines (supply and return) at a 90° elbow. The test pressure is 150 psi and the soil is soft clay.

TABLE 1 POUNDS OF THRUST AT FITTING FOR 100 POUNDS/ SQ. INCH OPERATING PRESSURE				TABLE 2 SAFE BEARING LOADS	
PIPE SIZE	TEE	90°	45°	SOIL	LB. PER SQ. FT.
2"	445	625	340	Muck, Peat	0
2½"	650	920	500	Soft Clay	1,000
3"	960	1,360	735	Sand	2,000
4"	1,590	2,250	1,215	Sand & Gravel	3,000
6"	3,450	4,875	2,640	Sand & Gravel cemented with clay	4,000
8"	5,840	8,260	4,470	Hard Shale	10,000
10"	9,080	12,830	6,945		
12"	12,770	18,050	9,770		

STEP 1 FINDING THRUST:

From Table 1, the resultant thrust of a 4" x 90° elbow is 2250 lbs. at 100 psi.

At 150 psi, the thrust is:

$$2250 \text{ lbs.} \times \frac{150 \text{ psi}}{100 \text{ psi}} = 3375 \text{ lbs. elbow}$$

3375 lbs. x 2 = 6750 lbs. thrust for two elbows.

STEP 2 FINDING BEARING AREA OF BLOCK:

From Table 2, soft clay has a bearing strength of 1000 lbs./ sq. ft. therefore:

$$\frac{6750 \text{ lbs.}}{1000 \text{ lbs./ sq. ft.}} = 6.75 \text{ sq. ft. bearing area required}$$

or a block face of 4' x 2' (8 sq. ft.) is adequate.

THRUST BLOCK TYPES

Examples of thrust blocks for normal fittings are illustrated.

For vertical risers the trench bottom must be undercut, and the entire trench bottom should be covered with concrete. The thrust blocks must bear against firm, stable soil.

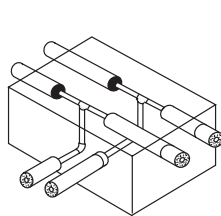

FIGURE II

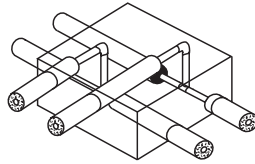

FIGURE I

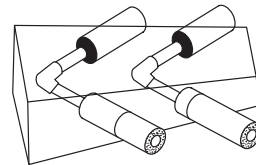

FIGURE III

CONSTRUCTION

Thrust blocks are made of concrete.

An acceptable concrete is 1 part Portland cement, 2 parts washed sand, and 3 parts washed gravel with enough water for a relatively dry mix. The dry mix is easier to shape and offers higher strength.

The concrete should be worked thoroughly around the elbows for maximum surface contact. Make sure the entire area between the fittings and the trench wall is filled with concrete and free of voids.

The blocks should be shaped with the designed bearing area against the trench wall. Smaller blocks should be shaped by hand. Larger blocks require simple forms.

The trench should be undercut under the pipes at least six inches to give added thrust resistance and to provide adequate concrete around the fittings. Six inches of concrete should be over the top of the pipe.

The center of the thrust blocks bearing surface should coincide with the horizontal center line of the pipes. (See figures I and II).

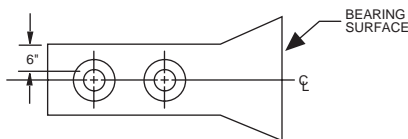

FIGURE I

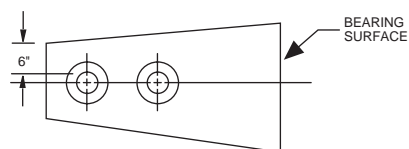

FIGURE II

UNSTABLE SOIL

If the soil is unstable in the area of a thrust block, it will be necessary for the engineer to make special provisions. This is considered a civil engineering matter and a project civil engineer should be consulted for professional advice.

VALVE BLOCKS

Blocks must be poured beneath valves with sufficient steel for valve connections. This supports the valve weight and prevents any torque or twisting action caused by opening and closing the valve.

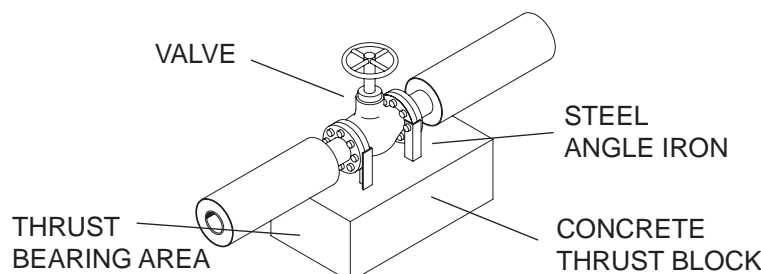

SHIPPING & HANDLING INSTRUCTIONS

HANDLE COATED PIPE WITH EXTRA CARE! THIS PIPE CAN DAMAGE WHEN HANDLED, MOVED, OR STORED IMPROPERLY!

UPON RECEIPT OF MATERIALS

Make an overall inspection of the load, checking all bands and braces to see if they are intact. Also, check the load for shifting. If the load has shifted, or if the braces and bands are broken, examine each pipe for damage. HAVE THE TRUCK DRIVER MAKE AN ITEMIZED NOTATION OF ANY DAMAGE ON THE DELIVERY RECEIPT AND HAVE IT SIGNED BY THE DRIVER.

CHECK PACKING LIST

Compare materials received with those listed on the packing list. Count all pipe and boxes. NOTE ANY SHORTAGES ON DRIVER'S DELIVERY RECEIPT.

CHECK BOXES

Open all boxes and inspect for damages, shortages, and correct size. REPORT ANY DISCREPANCIES WITHIN 30 DAYS AFTER RECEIPT.

CLAIMS FOR DAMAGES

Claims for damages in transit or lost goods must be made within 30 days. The filing of any claim is the Purchaser's Responsibility. Thermacor will file any claim on Purchaser's behalf upon receipt of the following:

1. Written authority to file such a claim.
2. Written notice of loss or damage (signed and noted Bill of Lading) by truck driver or carrier freight agent.

UNLOADING PIPE

Pipe may be unloaded by hand or with fork lifts*, cherry pickers, or cranes. DO NOT HOOK pipe ends. Minimum 4" wide straps or slings should be used.

*Fork Lift – When using Fork Lift, wide tines or a large surface covering the fork tines must be used to prevent coating damage. Fork Lift must be able to handle the weight of the insulated pipe length.

PIPE STOCKPILING

Pipe should be stored on level ground, elevated to be as dry as possible, and in such a way that the pipe ends do not lie in water or on the ground. To prevent deformation of the jacket and insulation due to the weight of the pipe, place a series of supports (3 for 20' or 5 for 40') of ample size generally constructed from 2" x 4"s under the pipe as shown below. Supports should increase in width as weight load increases so that the top supports of a fully loaded stockpile should be approximately 10" wide, gradually increasing to the bottom level, approximately 18" wide. Pipe can be pyramided (within reasonable and safe limits) approximately 6' high after a properly braced or chocked base is formed. Pipe stored outside for long periods of time can be covered with blue mesh tarpaulin (plywood can also be used). **Do not prevent airflow as jacket can be deformed from heat buildup.**

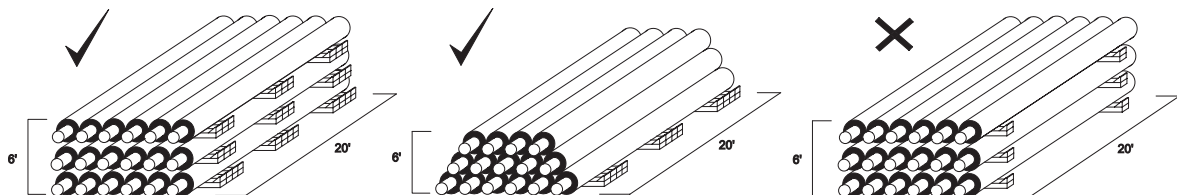

BE VERY CAREFUL NOT TO DROP THE PIPE!

NOTE: Thermacor does not approve of the practice of installing pipe and fittings, and backfilling the pipe before testing. Thermacor will not allow or pay claims for charges which arise in locating and digging up leaks regardless of cause.