



FIBER-THERM

Installation Manual

FBIM
9.201

GENERAL INSTALLATION INSTRUCTIONS

3.14.07

INSTALLATION INSTRUCTIONS

UNLOADING & HANDLING

Lift joints from trucks. DO NOT DROP SHARP OR HEAVY OBJECTS ON INSULATED UNITS. DO NOT use chains or other devices which might puncture insulation jacket.

STORAGE

Pipe is stockpiled off the ground. Do not exceed a stacking height of 6'. Prevent dirt and debris from entering pipe. Fittings, joining materials, etc. must be stored indoors to protect them from freezing, overheating, moisture, or loss.

LAYING OF PIPE UNITS – TRENCHING

All sharp rocks, roots, and other abrasive material must be removed from the trench. The trench bed should be 6" of sand or backfill as specified by the engineer, providing a smooth and uniform stabilizing surface (sandbags may be used as a means to keep the pipe off the ground until backfilling is started). The trench width should provide a minimum of 6" from trench wall to jacket O.D. and a minimum of 6" between pipe units. Trench depths will be indicated on the contract drawing and in line with good construction practices. Trench depth should allow for a minimum cover of 24" on top of the insulated unit.

FIELD JOINING METHODS

For all cases, follow the pipe manufacturer's instructions. The following is meant as a general guideline for Fiber-Therm 2000 FRP 2" thru 6" installation only. Insure that all taper and bonding surfaces are clean and dry. All pipe sockets, pipe ends, and fitting sockets should be sanded using 40 to 120 grit sandpaper. Sanding should remove the exterior gloss and resultant pipe should show a dull finish. Use a clean, dry cloth to remove all glass particles from surfaces to be bonded. Do not touch cleaned surfaces with hands or any other material that would deposit oil and impair proper joint adhesion. Protect the bonding surfaces from moisture, do not install in inclement weather, or at a minimum, protect the work area with tenting. If surfaces are moist, warm with heat blanket or heat gun and resand. If surfaces are oily or greasy, they should be resanded. All bonding surfaces must be sanded within two hours of assembly. NOTE: Special instructions are required for 8" and larger Fibertherm 2000 FRP.

Mix adhesive according to directions taking careful notice of the working life. Please review adhesive kit instructions prior to mixing. As a general guideline: Do NOT split kits. Mix all hardeners with adhesive. Thoroughly mix until color is uniform.

APPROXIMATE WORKING TIME

Adhesive Temperature	70°F / 21°C	80°F / 27°C	100°F / 38°C
Pot Life	30 min.	20 min.	8 min.

NUMBER OF BONDS PER KIT

Kit Size	2"	3"	4"	6"	8" thru 16"
3 oz.	4	3	2	1	see pipe literature
5 oz.	10	6	4	2	literature

Apply a thin, uniform coating of adhesive to the spigot, spigot end, and bell bonding surfaces. Enough adhesive should be used to form a bead surrounding the pipe when insertion has been completed. Only enough adhesive to wet the surfaces is needed. More is not better.

The spigot end should be inserted without rotation until contact of the matching taper in the bell is felt. DO NOT TWIST THE PIPE DURING INSERTION. After initial insertion of 8" pipe and larger, a come-a-long should be used to insure that the proper insertion depth has been obtained. Take careful notice to protect pipe with padding where the come-a-long is fastened. Support the winch on a wooden bridge across the joint so the winch can be left snug while the heating blanket cures the adhesive. Tap a wooden block held against the next bell end of the pipe to be sure the spigot end has been fully inserted. NEVER USE A HAMMER DIRECTLY ON THE FRP PIPE OR FITTING.

Place the thermostat end of heating blanket against the assembled joint (thermostat facing out). Wrap the remainder of the blanket around the joint so that any overlap will cover the thermostat. Tie the blanket in place with a nonconducting tie. Apply electric power to the blanket, simultaneously marking start time on the jacket. Insure that the blanket heats up and is working. A minimum 30-minute cure time for pipe joints and a 45-minute cure time for fitting joints is required. DO NOT MOVE pipe joint until pipe has cooled to touch for at least two hours.

FIELD ALTERATIONS

Pipe will be cut in the field, based on the appropriate field measurements for fittings and/ or making manhole or wall entries. If special lengths are required, measure distance needed for field alteration and cut through unit with hack saw or abrasive wheel. Using factory insulated pipe as guide, cut back insulation. Apply end seals to the clean, dry, exposed insulation surface. Check the squareness of cut with carpenter's square. Remove glassy resin material to bare fiberglass by sanding outer surface. Prepare pipe for joining as described in Field Joining Methods.

BACKFILL INITIAL

After pipe is installed, specified backfill shall be tamped around the conduit in 6" layers to insure proper compaction. One foot on either side of each joint and fitting shall be left bare for visual inspection during testing.

TESTING

Sufficient backfill must be placed on pipe and thrust blocks poured and cured, prior to testing. Bleed all air from lines to eliminate possible incorrect readings. The hydrostatic pressure test shall be performed per the engineer's specification with a factory recommendation of one and one-half times the normal operating pressure for not less than two hours. Inspect all fittings, valves, and couplings at this time. **NEVER TEST WITH AIR!** *Appropriate safety precautions shall be taken to guard against possible injury to personnel in the event of a failure.*

BACKFILL FINAL

Before backfilling is started, the trench should be cleaned of any trench wall cave-ins and general trash. Backfilling should be done with sand or other engineer-approved material 6" below the casing to 1' above. Engineer-approved backfill may be used to fill the rest of the trench. This material should be free of rocks, roots, large clods, or anything that could cause damage to the jacket. Jacket should have a minimum of 2' cover.

WHEELED OR TRACKED VEHICLES SHALL NOT BE USED FOR TAMPING!

THRUST BLOCK INSTALLATION

The engineer who designs the system has the responsibility for designing and sizing the thrust blocks. Knowledge of site soil conditions is essential for proper design. Thermacor will not accept or assume responsibility for thrust blocks, and intends to provide basic data only.

WHY THRUST BLOCKS?

A Fiber-Therm system must include thrust blocks to prevent any pipe movement from temperature changes. To prevent separation, thrust blocks must be located at:

1. All major changes in direction; i.e., tees and elbows (both horizontal and vertical).
2. All changes in size.
3. All terminal ends.
4. All Valves, so as to support the body weight and prevent excessive torque on pipe connections.
5. **IMPORTANT:** Any connecting metallic pipe must be anchored at the point of connection to the FRP pipe to prevent excessive stresses from being transferred to the FRP pipe.

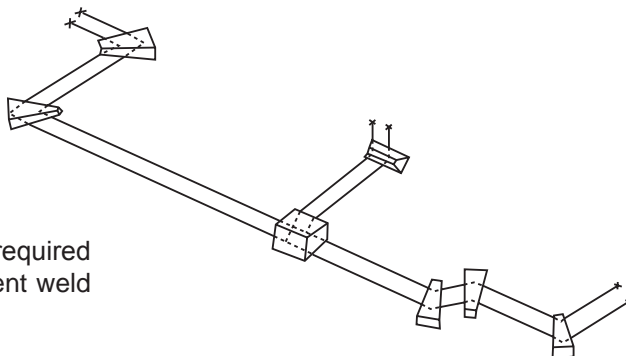

NOTE: Thrust blocks are required with gasket pipe and solvent weld fittings.

INSTALLATION

As thrust blocks are an essential part of the system, they should be poured before hydrostatic testing. Temporary thrust blocking may be used with extreme caution if absolutely necessary. The system must be retested after the permanent thrust blocks are poured and cured to verify that the thrust blocks will resist the thrust.

DESIGN

The design of the thrust blocks depends on test pressure, size, number of pipes, soil conditions, and types of fittings involved. Three conditions must be met for the thrust blocks to function properly.

1. The bearing area must be adequate to resist the pressure force.
2. The bearing surface must rest directly against undisturbed soil.
3. The face of the block bearing surface in the soil must be perpendicular to the resultant direction of thrust.

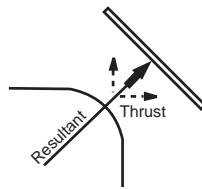

90° ELBOW

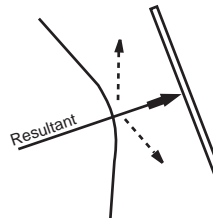

45° ELBOW

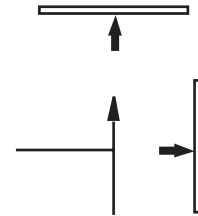

REDUCING TEE

If the thrust blocks have not been designed by the engineer, they must be sized by the following procedure:

Example: Design a thrust block to resist the horizontal thrust of two 4" hot water lines (supply and return) at a 90° elbow. The operating temperature of the system is 220° F and the soil is soft clay.

TABLE 1 POUNDS OF THRUST AT FITTING (FORCES ARE ASSUMED THE SAME THRU 250°F)				TABLE 2 SAFE BEARING LOADS	
PIPE SIZE	TEE	90°	45°	SOIL	LB. PER SQ. FT.
2"	2,300	3,250	1,760	Muck, Peat	0
3"	3,300	4,670	2,520	Soft Clay	1,000
4"	5,600	7,900	4,270	Sand	2,000
6"	8,300	11,700	6,350	Sand & Gravel	3,000
8"	12,000	17,000	9,200	Sand & Gravel cemented with clay	4,000
10"	15,000	21,200	11,500	Hard Shale	10,000
12"	17,900	25,400	13,700		

STEP 1

FINDING THRUST:

From Table 1, the resultant thrust of a 4" x 90° elbow is 7900 lbs.

7900 lbs. x 2 = 15800 lbs. thrust for two elbows.

STEP 2 FINDING BEARING AREA OF BLOCK:

From Table 2, soft clay has a bearing strength of 1000 lbs./ sq. ft. therefore:

$$\frac{15800 \text{ lbs.}}{1000 \text{ lbs./ sq. ft.}} = 15.8 \text{ sq. ft. bearing area required}$$

or a block face of 8' x 2' (16 sq. ft.) is adequate.

THRUST BLOCK TYPES

Examples of thrust blocks for normal fittings are illustrated.

For vertical risers the trench bottom must be undercut, and the entire trench bottom should be covered with concrete. The thrust blocks must bear against firm, stable soil.

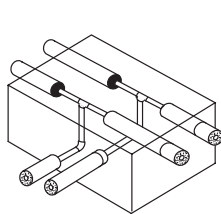

FIGURE II

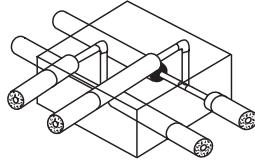

FIGURE I

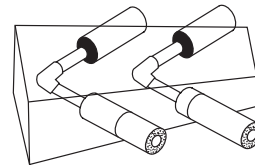

FIGURE III

CONSTRUCTION

Thrust blocks are made of concrete.

An acceptable concrete is 1 part Portland cement, 2 parts washed sand, and 3 parts washed gravel with enough water for a relatively dry mix. The dry mix is easier to shape and offers higher strength.

The concrete should be worked thoroughly around the elbows for maximum surface contact. Make sure the entire area between the fittings and the trench wall is filled with concrete and free of voids.

The blocks should be shaped with the designed bearing area against the trench wall. Smaller blocks should be shaped by hand. Larger blocks require simple forms.

The trench should be undercut under the pipes at least six inches to give added thrust resistance and to provide adequate concrete around the fittings. Six inches of concrete should be over the top of the pipe.

The center of the thrust blocks bearing surface should coincide with the horizontal center line of the pipes. (See figures I and II).

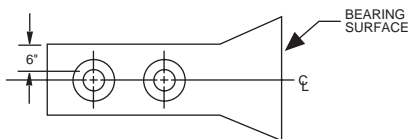

FIGURE I

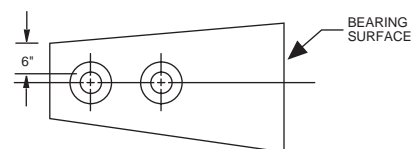

FIGURE II

UNSTABLE SOIL

If the soil is unstable in the area of a thrust block, it will be necessary for the engineer to make special provisions. This is considered a civil engineering matter and a project civil engineer should be consulted for professional advice.

VALVE BLOCKS

Blocks must be poured beneath valves with sufficient steel for valve connections. This supports the valve weight and prevents any torque or twisting action caused by opening and closing the valve.

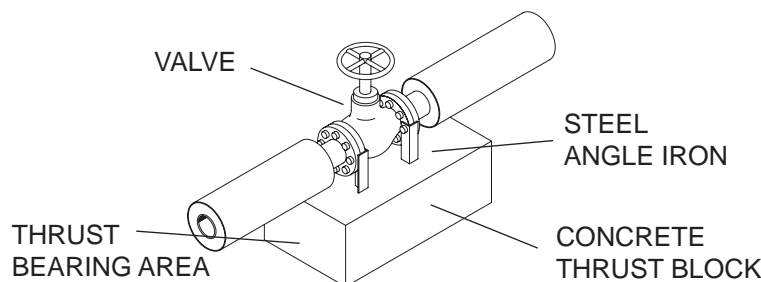

SHIPPING & HANDLING INSTRUCTIONS

HANDLE COATED PIPE WITH EXTRA CARE! THIS PIPE CAN DAMAGE WHEN HANDLED, MOVED, OR STORED IMPROPERLY!

UPON RECEIPT OF MATERIALS

Make an overall inspection of the load, checking all bands and braces to see if they are intact. Also, check the load for shifting. If the load has shifted, or if the braces and bands are broken, examine each pipe for damage. HAVE THE TRUCK DRIVER MAKE AN ITEMIZED NOTATION OF ANY DAMAGE ON THE DELIVERY RECEIPT AND HAVE IT SIGNED BY THE DRIVER.

CHECK PACKING LIST

Compare materials received with those listed on the packing list. Count all pipe and boxes. NOTE ANY SHORTAGES ON DRIVER'S DELIVERY RECEIPT.

CHECK BOXES

Open all boxes and inspect for damages, shortages, and correct size. REPORT ANY DISCREPANCIES WITHIN 30 DAYS AFTER RECEIPT.

CLAIMS FOR DAMAGES

Claims for damages in transit or lost goods must be made within 30 days. The filing of any claim is the Purchaser's Responsibility. Thermacor will file any claim on Purchaser's behalf upon receipt of the following:

1. Written authority to file such a claim.
2. Written notice of loss or damage (signed and noted Bill of Lading) by truck driver or carrier freight agent.

UNLOADING PIPE

Pipe may be unloaded by hand or with fork lifts*, cherry pickers, or cranes. DO NOT HOOK pipe ends. Minimum 4" wide straps or slings should be used.

*Fork Lift – When using Fork Lift, wide tines or a large surface covering the fork tines must be used to prevent coating damage. Fork Lift must be able to handle the weight of the insulated pipe length.

PIPE STOCKPILING

Pipe should be stored on level ground, elevated to be as dry as possible, and in such a way that the pipe ends do not lie in water or on the ground. To prevent deformation of the jacket and insulation due to the weight of the pipe, place a series of supports (3 for 20' or 5 for 40') of ample size generally constructed from 2" x 4"s under the pipe as shown below. Supports should increase in width as weight load increases so that the top supports of a fully loaded stockpile should be approximately 10" wide, gradually increasing to the bottom level, approximately 18" wide. Pipe can be pyramided (within reasonable and safe limits) approximately 6' high after a properly braced or chocked base is formed. Pipe stored outside for long periods of time can be covered with blue mesh tarpaulin (plywood can also be used). **Do not prevent airflow as jacket can be deformed from heat buildup.**

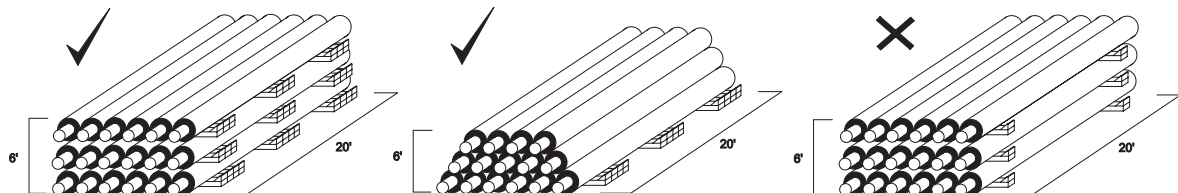

BE VERY CAREFUL NOT TO DROP THE PIPE!

NOTE: Thermacor does not approve of the practice of installing pipe and fittings, and backfilling the pipe before testing. Thermacor will not allow or pay claims for charges which arise in locating and digging up leaks regardless of cause.